

## TIMING RECEIVER FOR TIMATION SATELLITE

by

**Roger Easton**

Mr. Easton is Head, Space Metrology Branch, Naval Research Laboratory, Washington, D. C.

This paper presents a brief review of the various methods of time dissemination and a discussion of the timing receiver developed for use with the Timation satellites.

Four time transfer possibilities are listed in Figure 1. LORAN, OMEGA, and TV are suited for a fixed master-fixed user situation; user navigation is required for the fixed master-moving user. This report is concerned with items 3 and 4: when the master and/or the user are moving, precise knowledge of their locations is necessary.

There are two very closely related ways of time dissemination today: radio and navigation. Historically, the moons of Jupiter were used to obtain the first measurements of longitude. Later, the moon was used in a navigation system in which time could be determined to about 30 miles (a little over a minute). Time dissemination today uses the hyperbolic stations, LORAN and OMEGA, and satellites, which make possible the two-way ranging and passive ranging systems.

The satellite has four advantages: (1) well-known position; (2) line-of-sight signal, which allows the use of UHF; (3) worldwide coverage; and (4) a celestial navigation solution identical to the one used in celestial navigation for 200 years (see Figure 2). The diagram indicates the observer on a ship and his method of measuring the range to the satellite. He knows the radius of the Earth and the distance from the center of the Earth to the satellite. Triangulation gives him the angle  $\theta$ , the same angle a celestial

1. Fixed Master-Fixed User  
LORAN to fixed stations  
OMEGA  
TV
2. Fixed Master-Moving User  
User Navigation
3. Moving Master-Fixed User  
Master Navigation
4. Moving Master-Moving User  
Navigate Both Master and User

Figure 1. TIME TRANSFER POSSIBILITIES

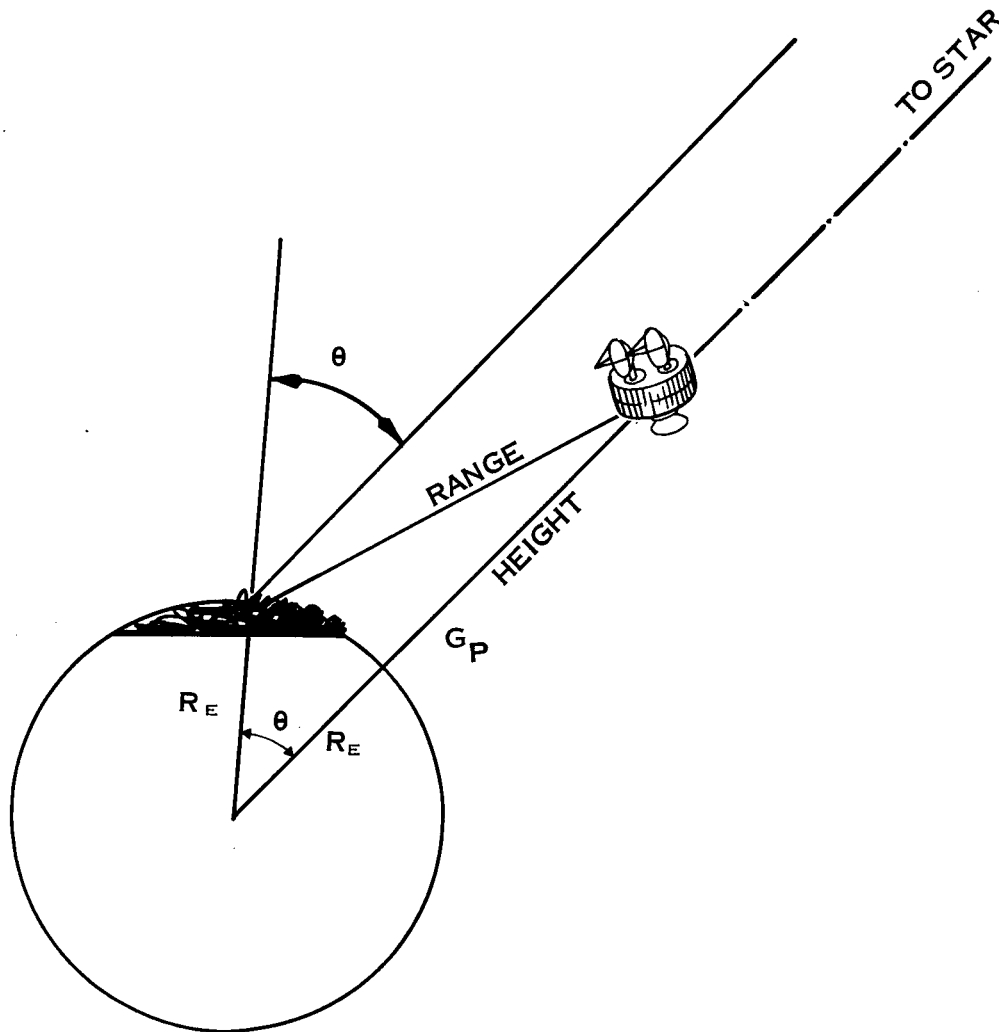

Figure 2. TRANSFORM TO CELESTIAL NAVIGATION

navigator would have used to observe a star in the same geographical position of the satellite.

Figure 3 is a diagram of range measurement by phase measure. The satellite has a clock (in this case, a 100-kHz clock) that is counted down: 100, 10, 1, .1 kHz. The observer has a similar clock. The signal from the satellite is received by the observer who then compares the phase of the 100 kHz received to his own 100 kHz to get a phase reading; he repeats this step for the other frequencies. If the satellite clock is synchronized to the observer clock, this phase reading gives a measurement of the time delay between the satellite and the observer.

Figure 4 is a schematic of the actual procedure, measured in 6800, 920, 18, and 8.6, 10 microseconds, with 100-cycle, 1000, and 10,000 microseconds countdown. The satellite clocks and the navigator clocks are synchronized in this case. However, by the time this signal gets from the satellite to the navigator, his clock has changed because it took 6800 microseconds for the signal to arrive. The phase comparison for the first clock is .68 of a cycle, which gives a rough reading of 6800 microseconds. For the second clock, the reading is .92, so it should read 6920 microseconds. For the third clock the reading is .18, so it should read 6918 microseconds, and for the fourth clock it is 8.6, so it should read 6918.6 microseconds.

Figure 5 is an intercept chart invented a hundred years ago by St. Hilaire, a French naval officer. The precomputed chart shows the assumed position, the direction of the satellite at 16 minutes past the hour and the computed time delays from the satellite at 16 minutes past the hour (10,870 microseconds). Thus, one can plot the predicted satellite positions for these times, compute the distance from the satellite to the assumed position, and convert this to time delay.

Figure 6 shows a fix determined on the intercept chart. At 16 minutes past the hour the time delay is read, a right angle is drawn, and a line of position (LOP) is established. Other LOP's are drawn in similar fashion.

Observer Clock

Satellite Clock

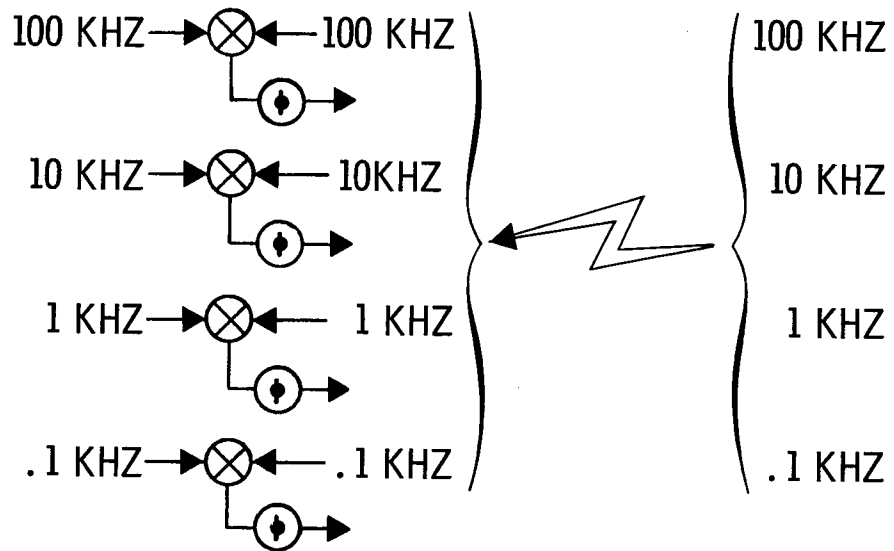
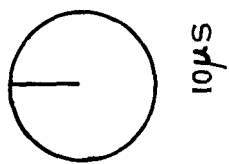
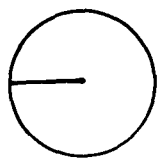

Figure 3. RANGE MEASUREMENT BY PHASE MEASUREMENT



10  $\mu$ S

6800  
920  
18  
8.6



100

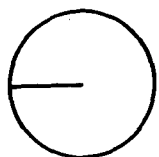

1000

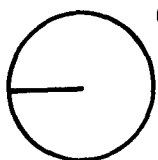

10,000  $\mu$ S

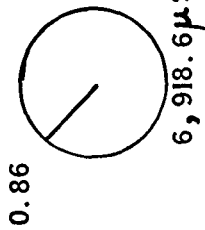
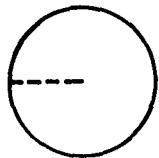

0.86

6,918.6  $\mu$ S

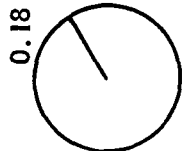
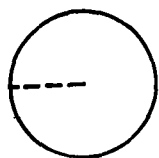

0.18

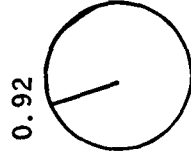
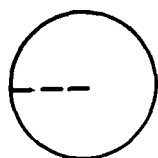

0.92

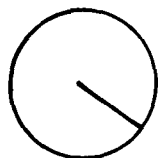
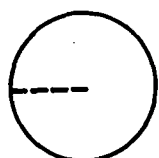

0.68

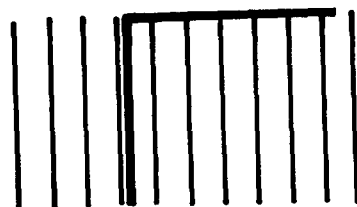
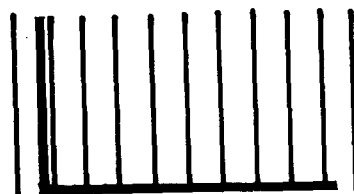
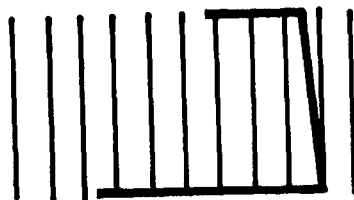
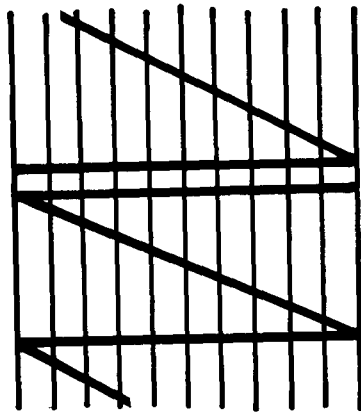

Figure 4. SCHEMATIC PROCEDURE

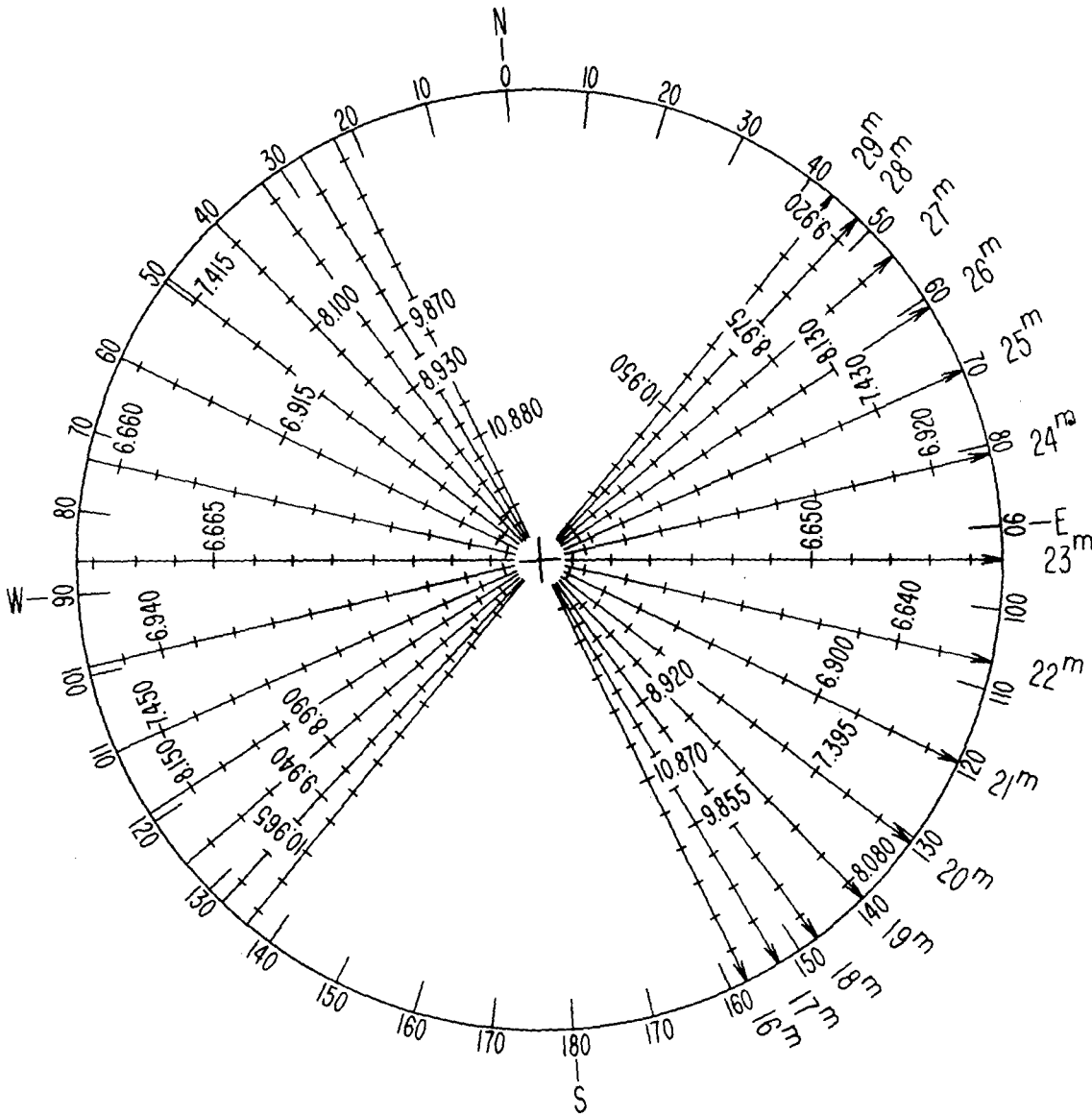

Figure 5. PRECOMPUTED INTERCEPT CHART

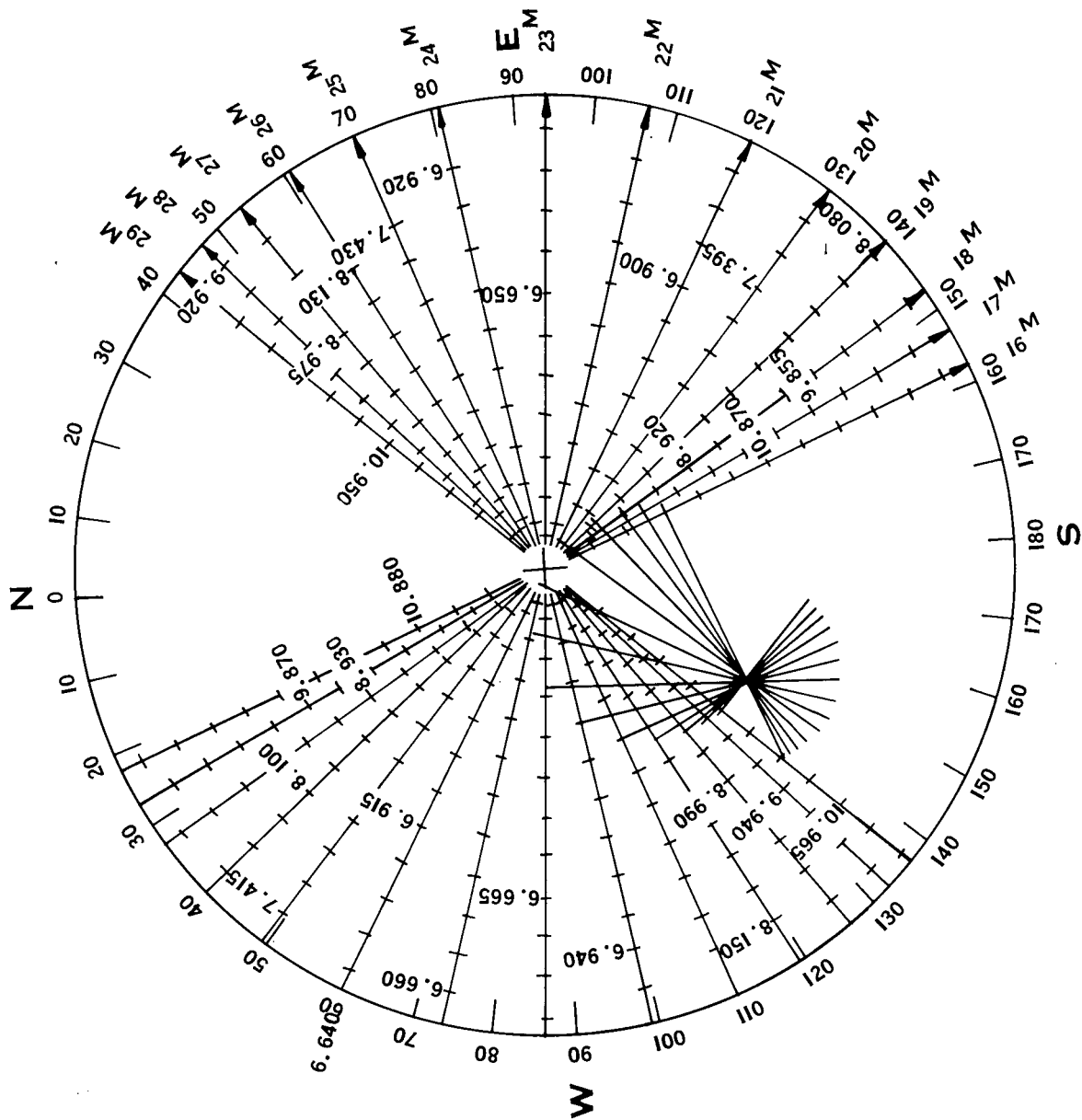

Figure 6. FIX DETERMINED ON INTERCEPT CHART





If there are no errors, the fix is perfect. But more often than not, the result will be similar to that pictured in Figure 7, an intercept chart showing the effect of synchronization error on plot, which is identical to having an instrument error for a celestial fix. The navigator is at the center of the arc of the circle, and the radius is his time error between his clock and the satellite clock. Thus the use of this technique allows both navigation and time transfer.

Figure 8 is a picture of the satellite in current use, Timation II. It was launched over two years ago on the aft rack of an agena. Table I lists the characteristics of Timation I (which failed after two years because of the failure of the gravity gradient boom), Timation II, and Timation III (scheduled for December, 1972).

Table 1.

TIMATION SATELLITES			
	#I	#II	#III
Launch Date	31 May 1967	30 Sept 1969	Proposed
Altitude	500	500	7500 n. mi.
Inclination	70°	70°	96°
Weight	85 lb	125 lb	360 lb
DC Power	6 W	18 W	50 W
Frequencies	400 MHz	150&400	400, 1600 MHz
Max Mod Freq	100 kHz	1 MHz	8 MHz
Osc Stab	3pp10 <sup>11</sup>	.5-1pp10 <sup>11</sup>	1-2pp10 <sup>12</sup>

Figure 9 shows the aging rates of the oscillators on Timation I and II. When the crystal oscillator on Timation II (which is tunable from the ground) was launched into space, it had a positive aging rate, 2 parts in 10<sup>11</sup> per day. This rapidly decreased to more than minus 4 parts in 10<sup>11</sup>

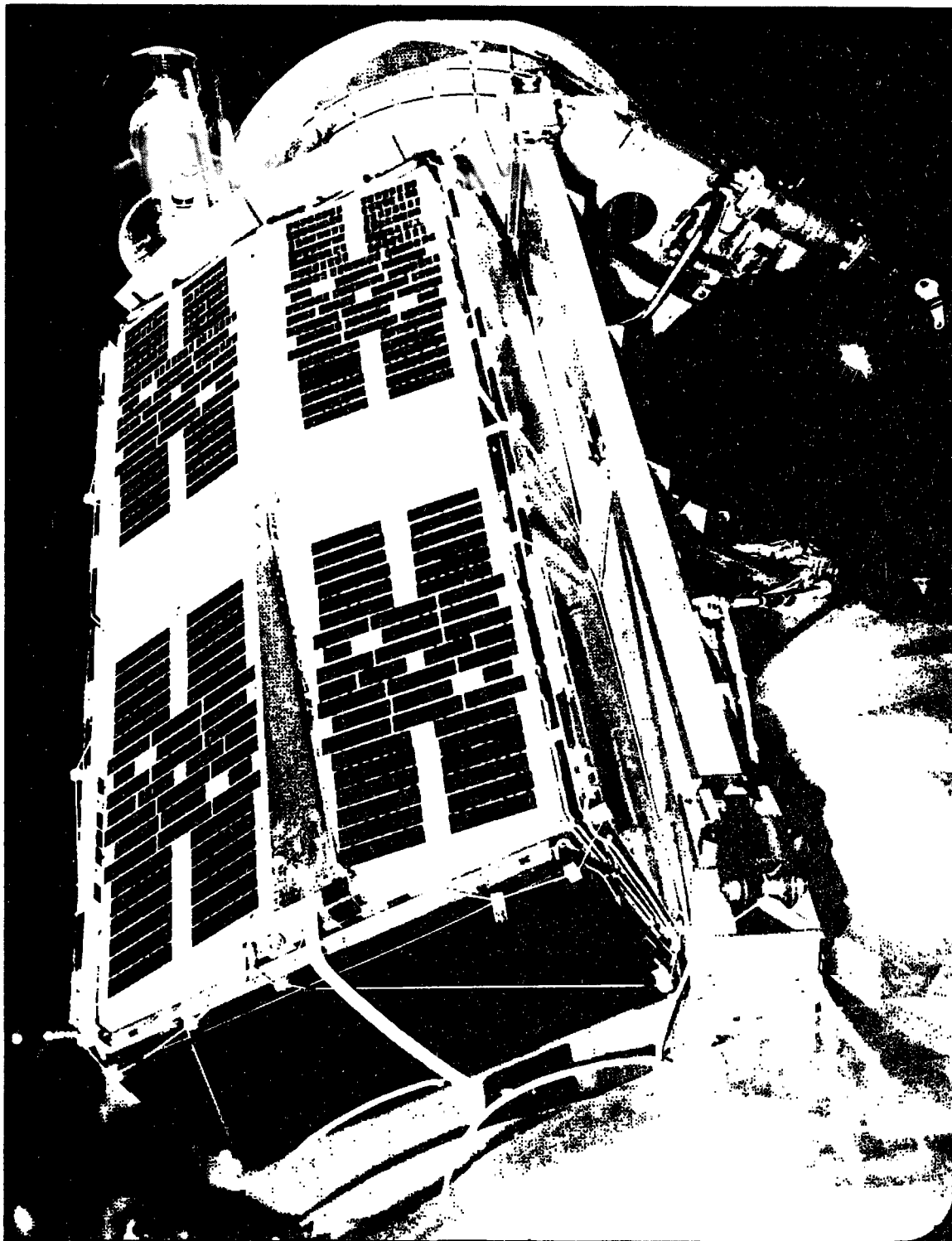

Figure 8. TIMATION II

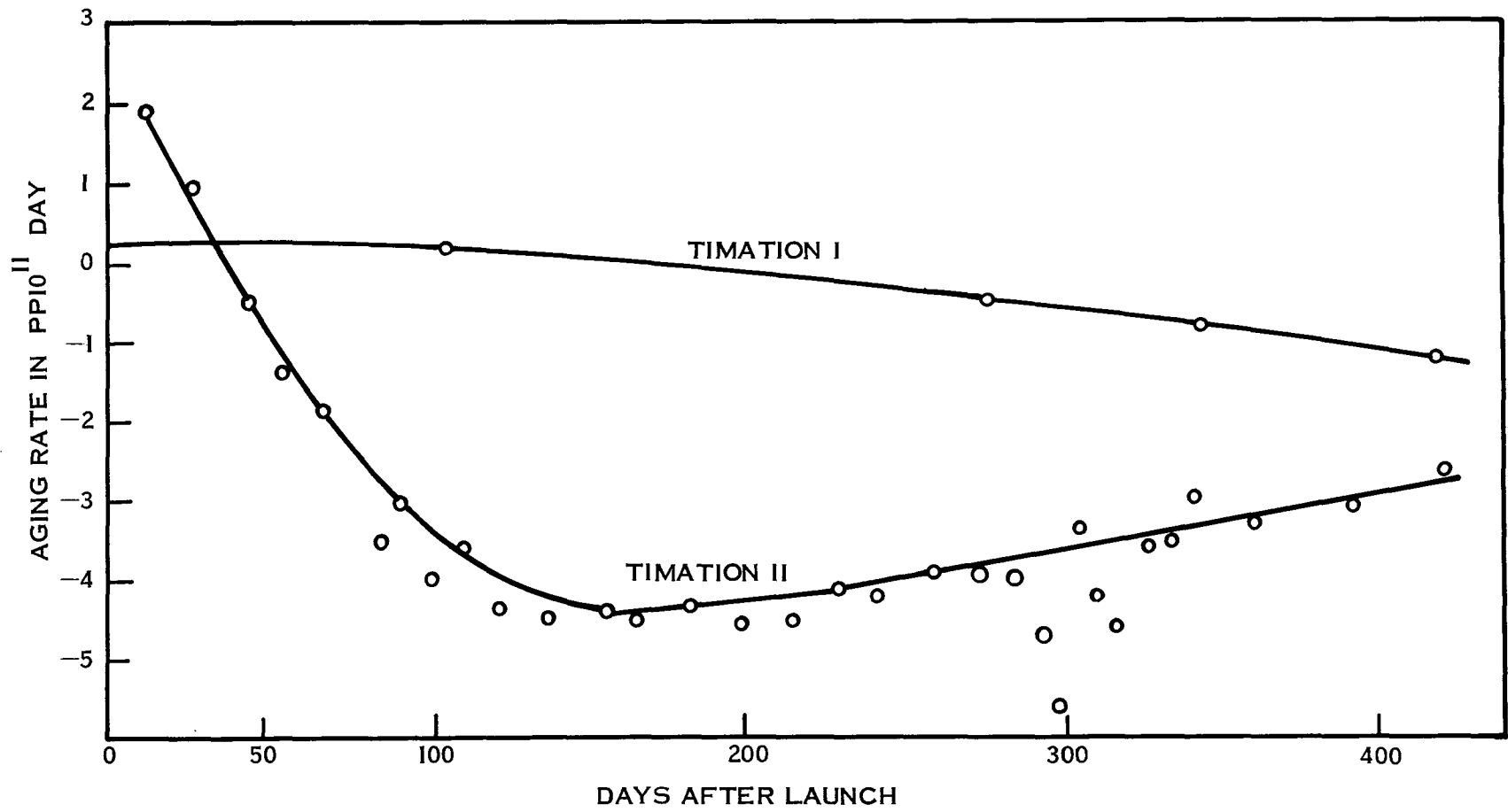

Figure 9. AGING RATES OF CRYSTAL OSCILLATOR

and has now come back up to minus 2 parts in  $10^{11}$  per day. This would not be expected from any ground measurements. The rate of Timation I started as a much lower rate and gradually became more negative. The difference was caused by proton bombardment on the crystal; the reason for the different shapes of the curves is that Timation I had a much higher positive coefficient when it was launched and the proton bombardment (largely proton, some electron) compensated for it almost directly, thus the almost zero aging rate. Timation II had a much lower aging rate and the protons overcompensated for it, which caused the highly negative aging rate for part of the time. It was determined that the rate was largely caused by protons because Timation II had a lead shield that shielded out the electrons, and it still had almost the same rate that would have been expected without the lead shield.

Figure 10 is a schematic of Timation III. It is a large satellite, 5 feet in diameter, with a double gravity gradient boom and antennas on both ends, so no matter which way the gravity gradient captures, it can operate. At this altitude the gravity gradient takes about 3 weeks to stabilize, so it is not desirable to turn it over very often.

Figure 11 is a photograph of the 400-megahertz time dissemination receiver. It is designed to resolve ambiguities; i.e., it makes a reading, carries the reading on, resolves the ambiguity in steps of time, and reads out the time delay directly.

Figures 12 and 13 are graphs of time measurement errors made by the timing receiver, which illustrate that the occasional error made by the device can usually be corrected.

Figures 14 and 15 are graphs comparing time measurement errors made by the NRL-RCA receivers.

Figure 16 charts satellite clock errors with 4- and 6-day predictions. Data received from the Naval Weapons Laboratory on the orbit ephemeris

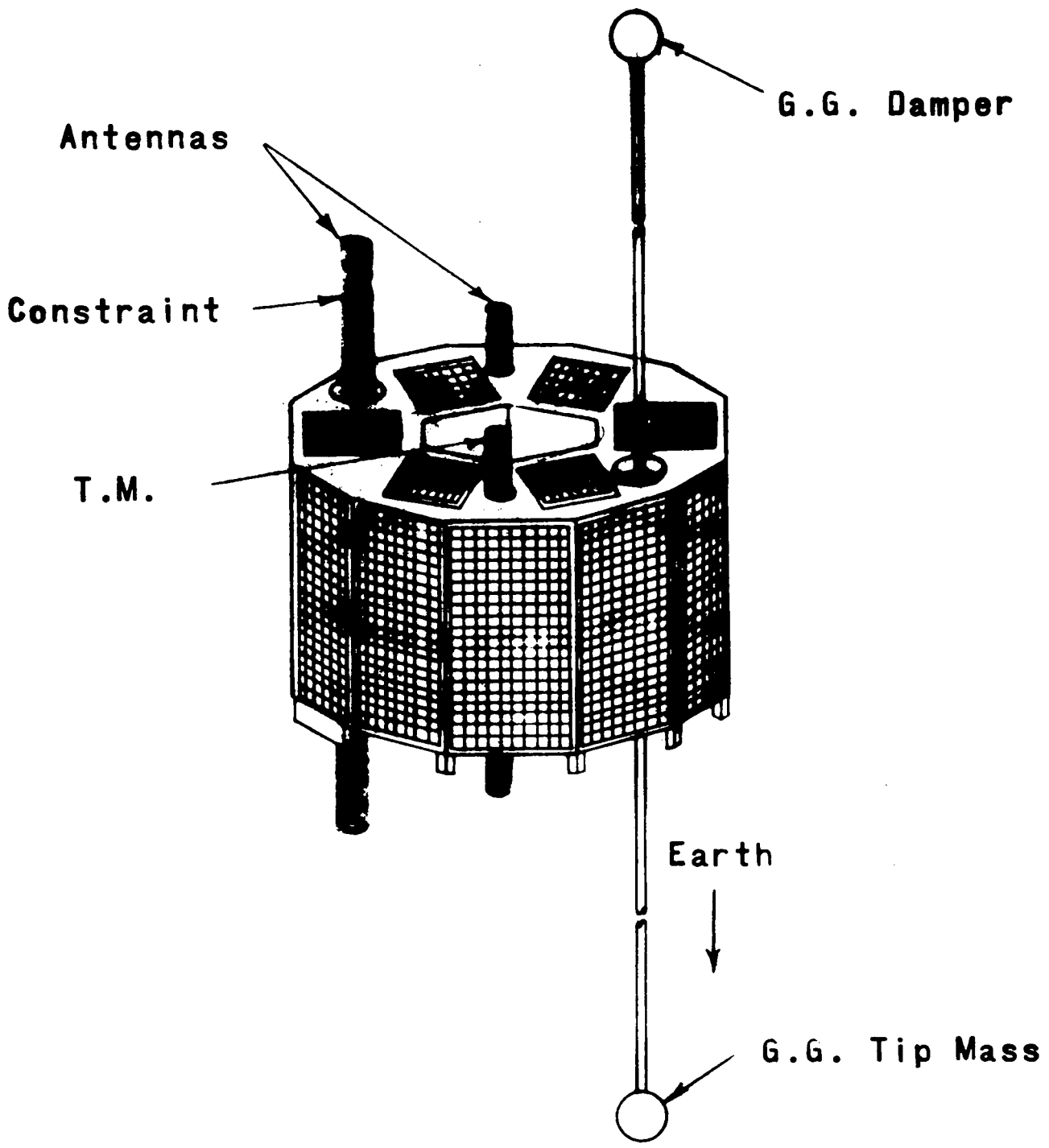

Figure 10. TIMATION III ORBIT CONFIGURATION

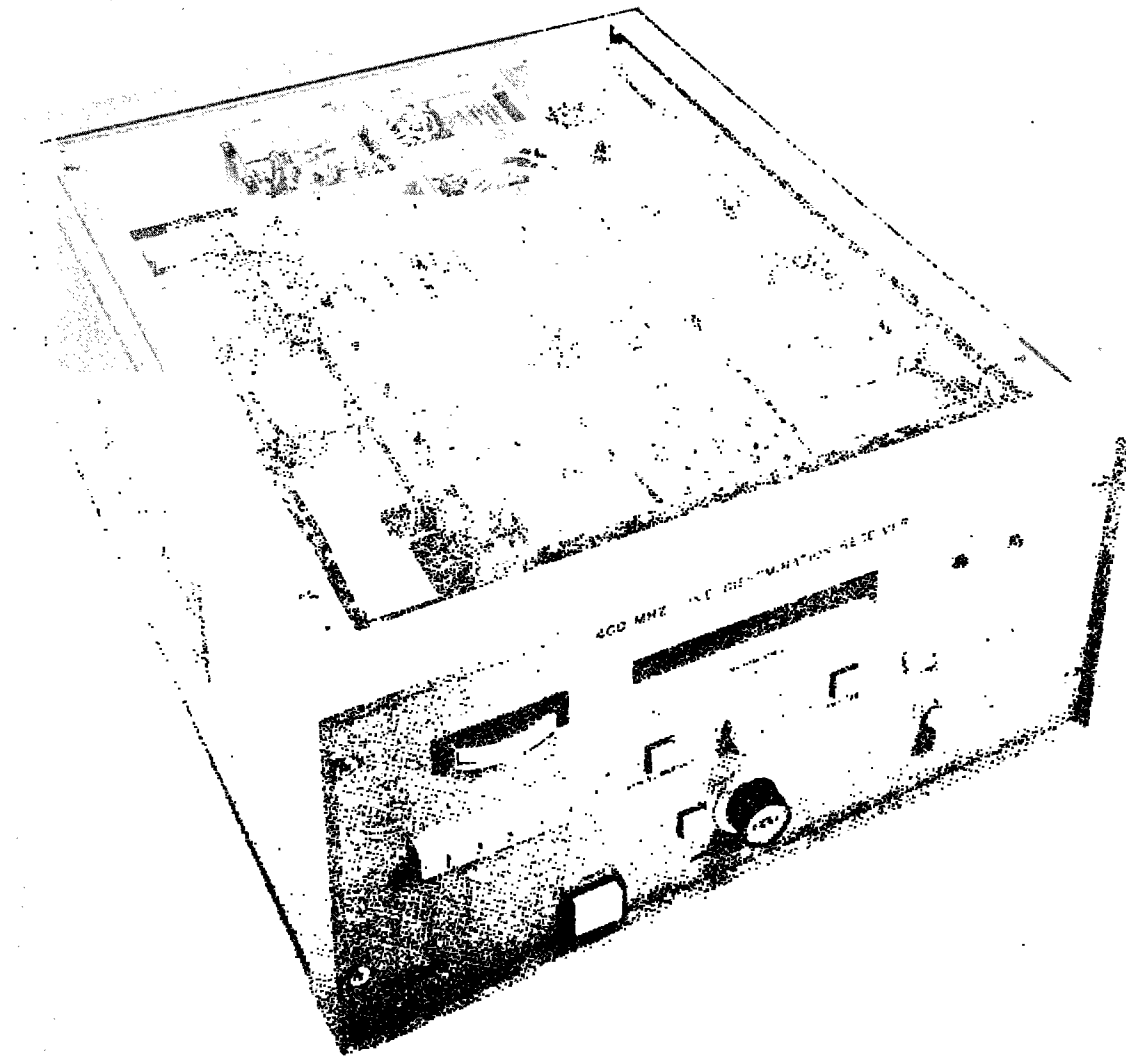

Figure 11. 400 MEGAHERTZ TIME DISSEMINATION RECEIVER

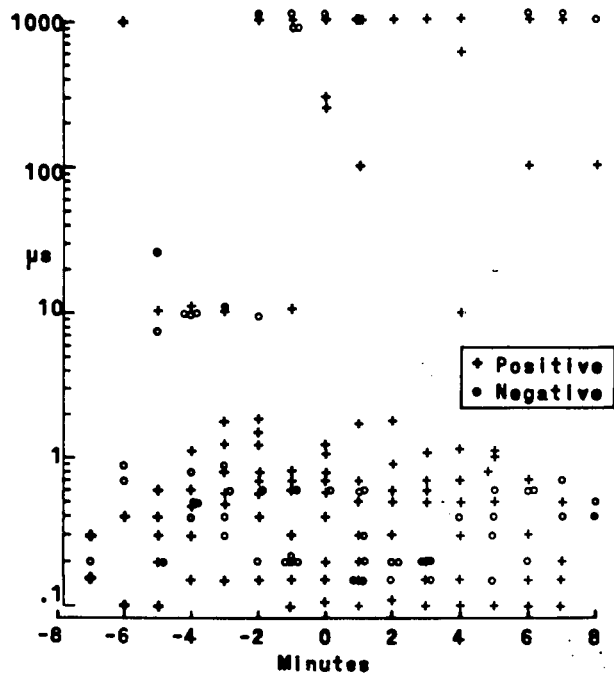

Figure 12. TIME MEASUREMENT ERRORS

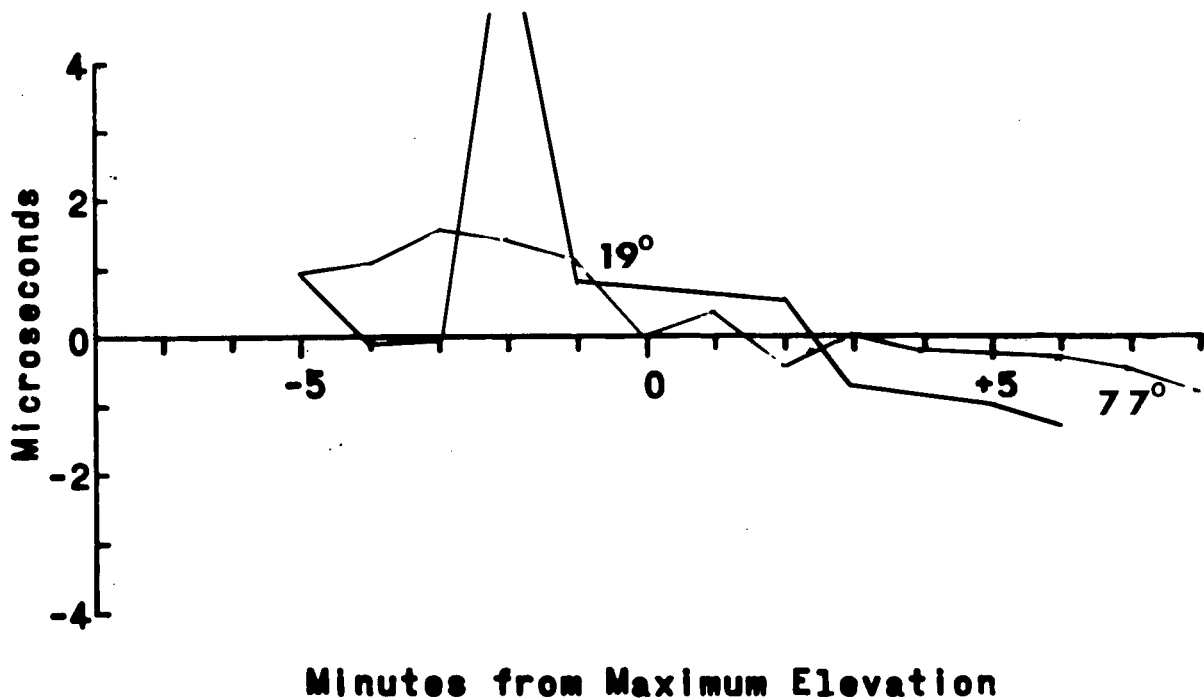

Figure 13. TIME ERRORS FOR PASSES ON 12 NOVEMBER



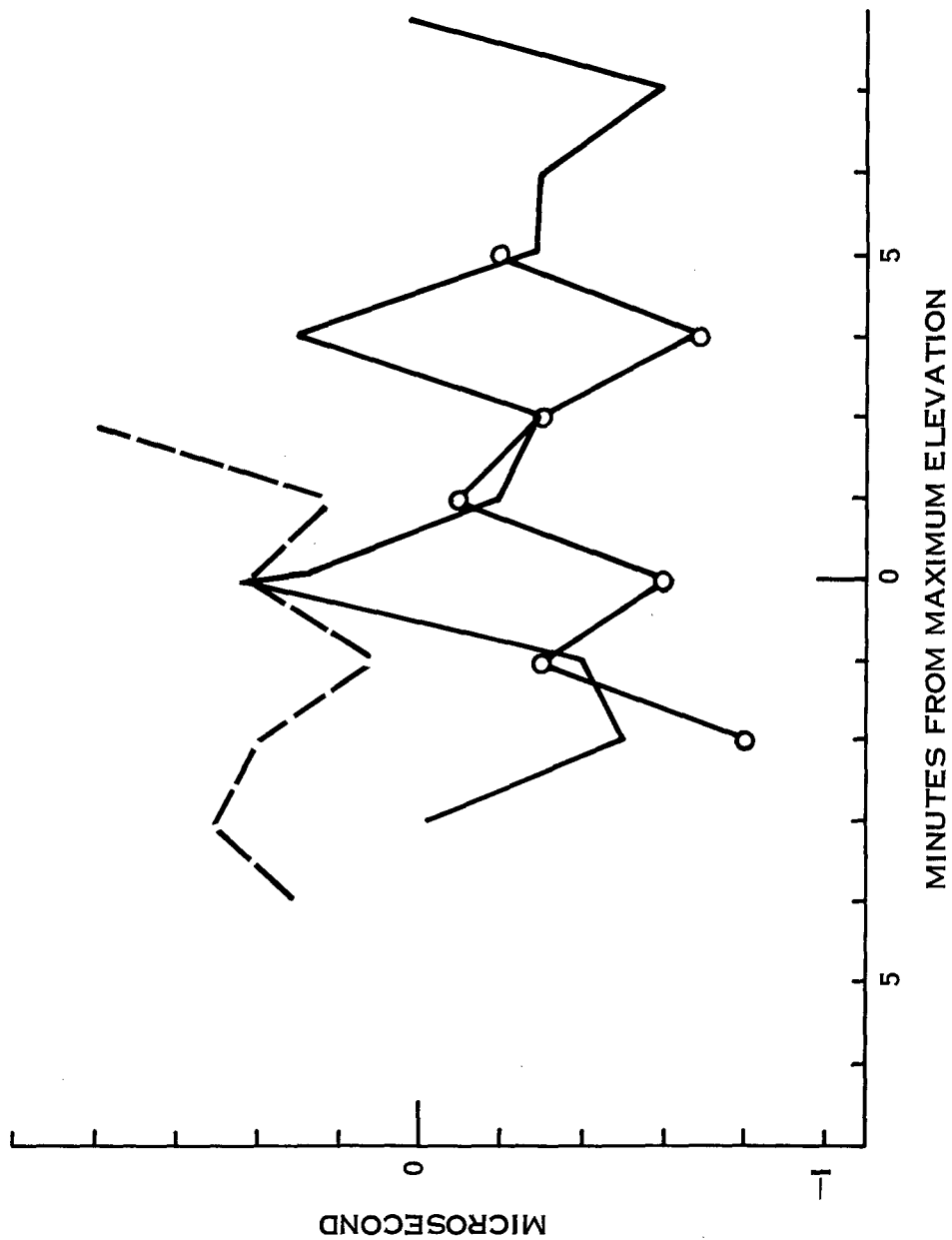

Figure 14. NRL-RCA RECEIVER COMPARISON

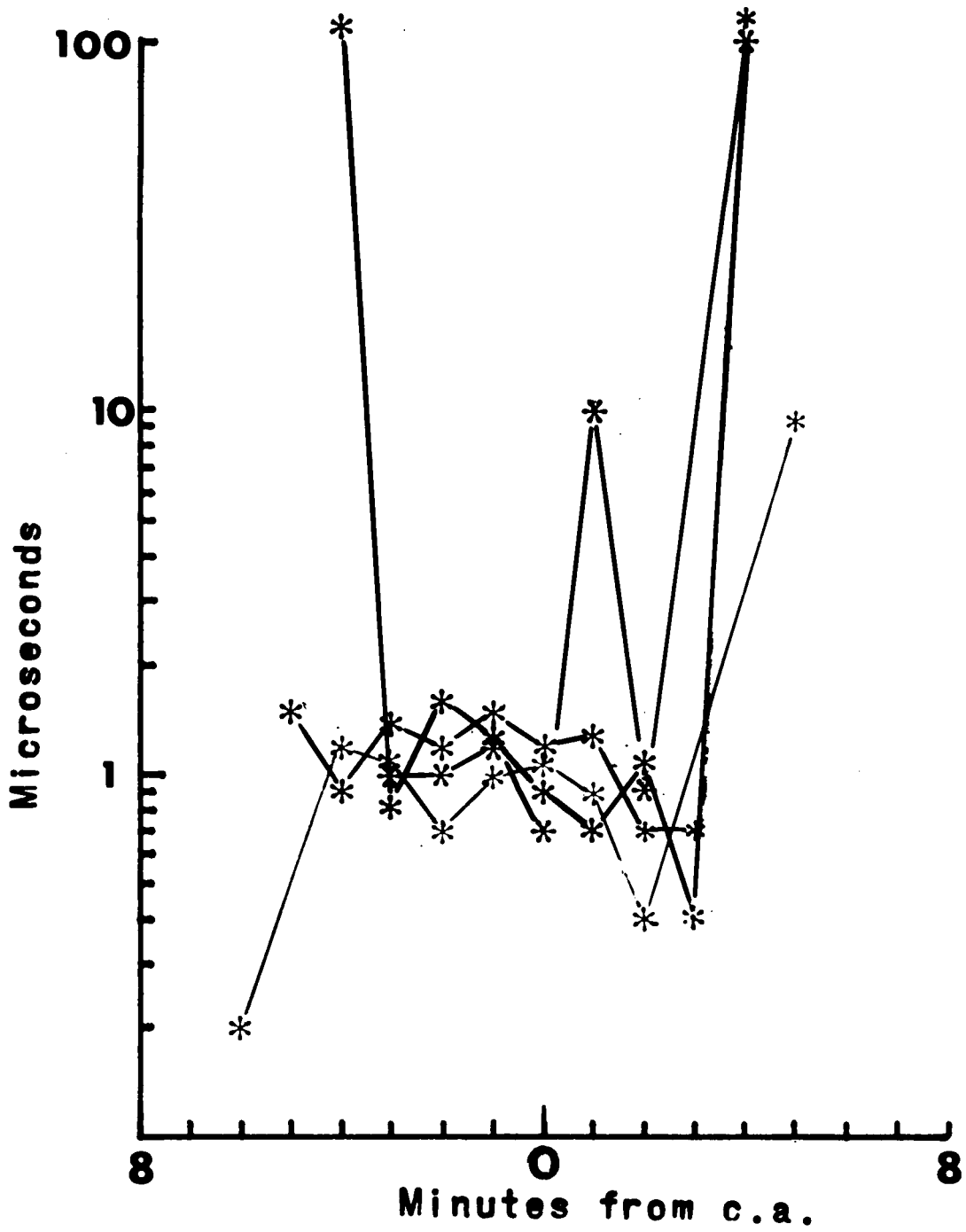

Figure 15. TIME MEASUREMENT ERRORS NRL-RCA

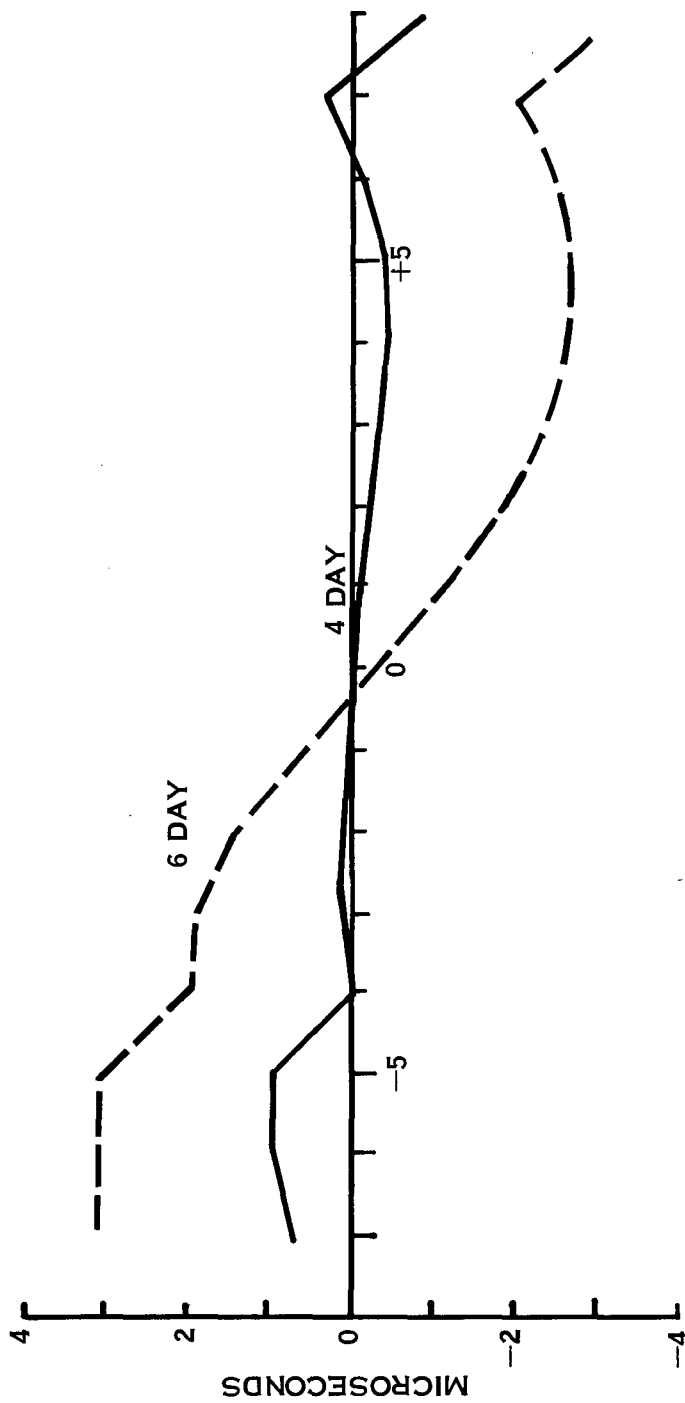

Figure 16. CLOCK ERRORS WITH 4 AND 6 DAY PREDICTIONS

were 4 and 6 days old; with the 4-day old data, the maximum error was a little more than a microsecond, and with the 6-day old data it was between 3 and 4 microseconds.

Five steps are taken for routine satellite clock update: (1) The satellite position is determined by use of TRANET, a tracking net for geodetic satellites operated by PM 16 of the Navy. TRANET looks at the satellite as though it were a doppler satellite, sends the data to the Applied Physics Laboratory, where they are processed somewhat and then sent to the Naval Weapons Laboratory, which then gives predictions on where the satellite will be and post-dictions on where it was. (2) The Naval Weapons Laboratory computes the time delay from the satellite to the stations in question (e.g., NRL). (3) The local clock is compared to the master clock, which is ultimately compared to the Naval Observatory Clock. (4) Time delay from the satellite is measured. (5) By measuring these time delays on sequential days, the clock drift of the satellite (which is now about 2 parts in  $10^{11}$  per day) is obtained.

Three steps are taken to obtain time transfer measurement. (1) The time delay from the satellite to the stations is computed. (2) The time delay is measured and compared with the computation. (3) The oscillator drift measurement is used to correct the times of the remote station, if it is a considerable distance away from the master station.

Figure 17 shows the predicted positions of the satellite pass for 16 November 1971, and Figure 18 gives the calculated and observed delays.

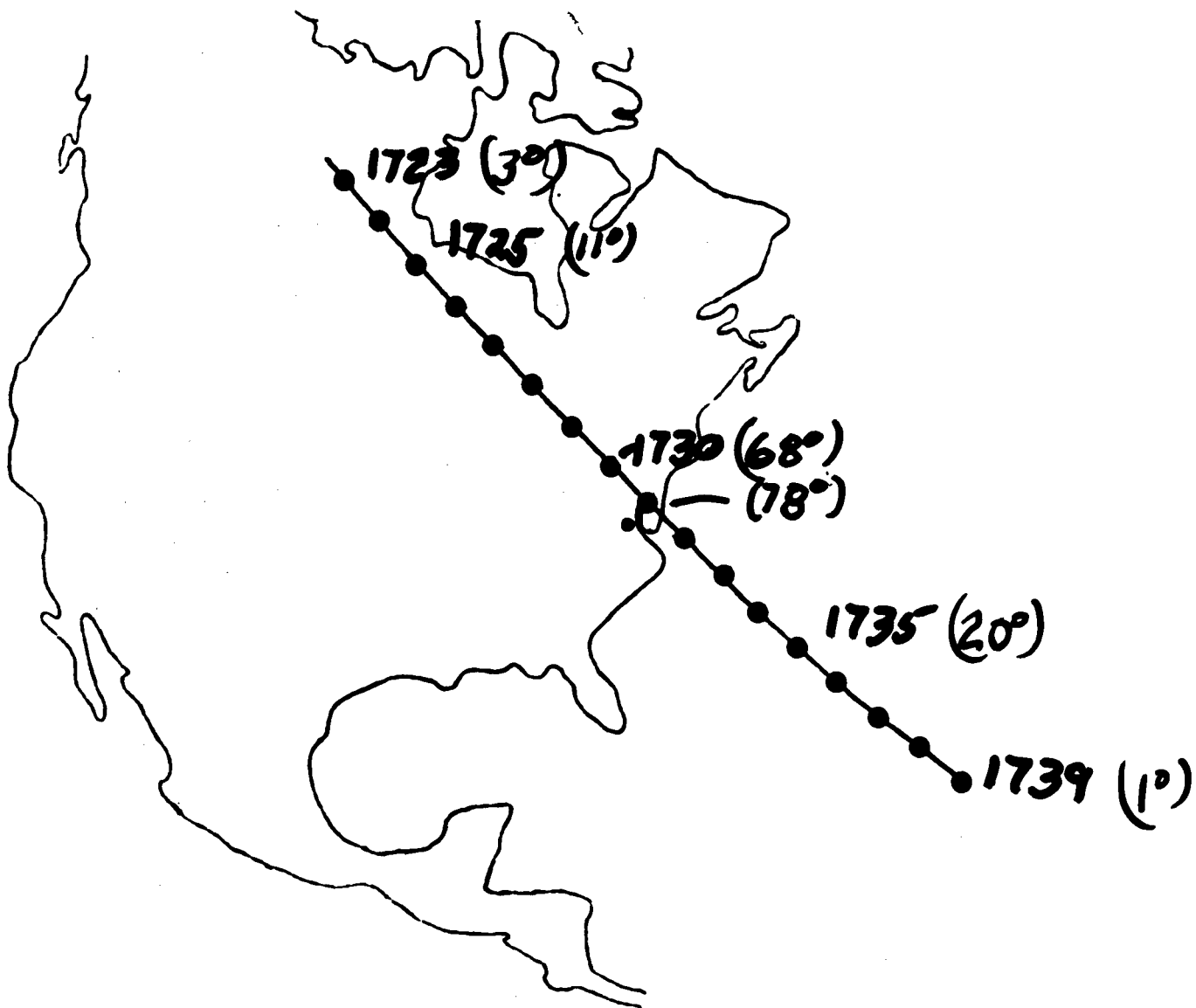

Figure 17. SATELLITE GROUND TRACK FOR 16 NOVEMBER 1971 PASS

		$\Delta t$			$\Delta t$
1723	<u>10,554.49</u>		1731	2,154.88 } <u>3,155.11</u> }	-1000.23
1724	<u>9,299.41</u>			2,674.11 } <u>3,674.81</u> }	-1000.70
	8,159.11 } 8,057.93 }	101.22	1733	4,548.72 } <u>4,549.80</u> }	- 1.08
1725	6,944.29 } <u>6,843.25</u> }	101.04	1734	5,613.15 } <u>5,614.28</u> }	- 1.13
1726	5,680.19 } <u>5,678.50</u> }	1.69	1735	6,784.34 } <u>6,776.82</u> }	+ 7.52
1727	4,609.06 } <u>4,607.65</u> }	1.41	1736	7,990.26 } <u>7,991.64</u> }	- 1.38
1728	3,719.47 } <u>3,718.44</u> }	1.03	1737	9,233.29 } <u>9,234.72</u> }	- 1.43
1729	3,172.70 } <u>3,172.23</u> }	.47	1738	10,491.34 } <u>10,492.42</u> }	- 1.08
1730				11,254.39 } <u>11,756.32</u> }	- 1.93
			1739		

\* calculated is underlined; observed is not underlined

Figure 18. CALCULATED AND OBSERVED DELAYS\*

## DISCUSSION

LCDR POTTS: What are the error mechanisms that cause the ambiguities of 100 microseconds, 1000 microseconds in the reading?

MR. EASTON: It's just noise in the system from one place to another. The signal level we're using is not too high, and the noise makes us resolve the times wrong.

MR. GATTERER: If this were an operational system available to anybody, what would it cost a user to receive this signal at the various accuracy levels? What would it cost in terms of equipping and setting up in the first place? What would it cost in terms of manpower to operate?

MR. EASTON: We've heard figures all the way from, say, a dozen receivers like this for something like \$20,000 each. And if you were in the thousands category; for instance, you had a real navigation system going and you wanted down to the fairly cheap system, which would be a single frequency system, we've heard figures below \$1000. If you went to the best, two frequencies, why of course, you're going to a higher value. But somewhere between \$1000 and \$20,000, depending on the number you want, I think it is a reasonable span, anyway.

MR. GATTERER: What about manpower?

MR. EASTON: It takes one man to read off the data once you get it set up. It's not a big manpower problem.

MR. WILCOX: I'm wondering about the gravity gradient boom; just how does that compensate for the gravity gradient?

MR. EASTON: The gravity on one end of the boom is different from the gravity on the other, and, since there's very little drag or anything else at that altitude, by having a damper in one tip mast, you can damp out the effect of gravity. It will give you a two-axis stabilized satellite, either pointing toward the Earth or away, depending on which way you want to look at it.

DR. REDER: I'm puzzled by those curves which you showed on the aging of the crystal. You say it's because of protons?

MR. EASTON: That's correct. That's what we think it is.

DR. REDER: How long is this satellite in orbit?

MR. EASTON: The second one has been just over two years, and the first one, four years.

DR. REDER: Well, did you notice any change in the aging rate during a proton flare of the sun?

MR. EASTON: No, and we probably wouldn't. We wouldn't have enough sensitivity to notice that.

DR. REDER: Well, the proton flares have an increase in flux rate, in some cases up to two or three thousand.

MR. EASTON: Right, but we have quite a few errors in our measurement and we haven't noticed it. Possibly we could.

MR. BARNABA: You mentioned this oscillator in your Timation II satellite, parts in  $10^{12}$ . Could you describe that?

MR. EASTON: Well, it's just a crystal oscillator which, hopefully, is, you know, the-state-of-the-art, much smoother grind, much higher temperature bake-out, much higher vacuum, and carefully selected from a large number. Right now, it doesn't look like we'll get one part in  $10^{12}$ ; two parts in  $10^{12}$  is probably as good as we will do.

MR. LIEBERMAN: I noticed that you have a single satellite up for both II and III. Are you going to have clusters, or just single satellites?

MR. EASTON: Well, that gets into the whole DOD navigation area. How many and whether they will go into a new navigation system are still undecided questions.